

1

2

3

A

A

B

B

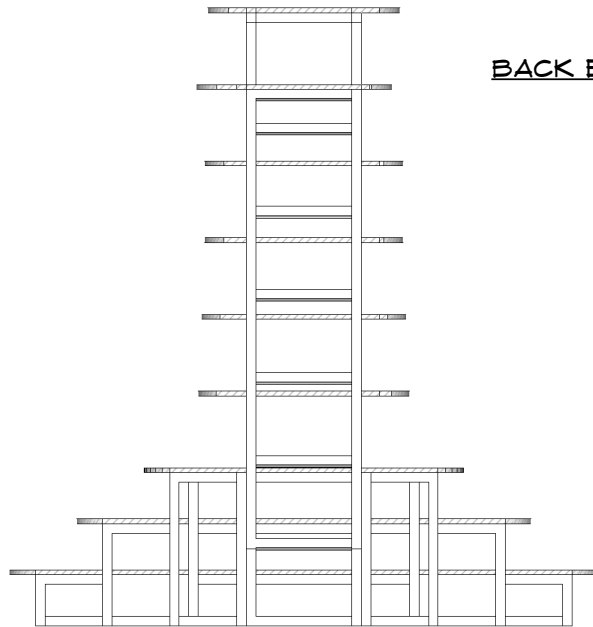

BACK ELEVATION

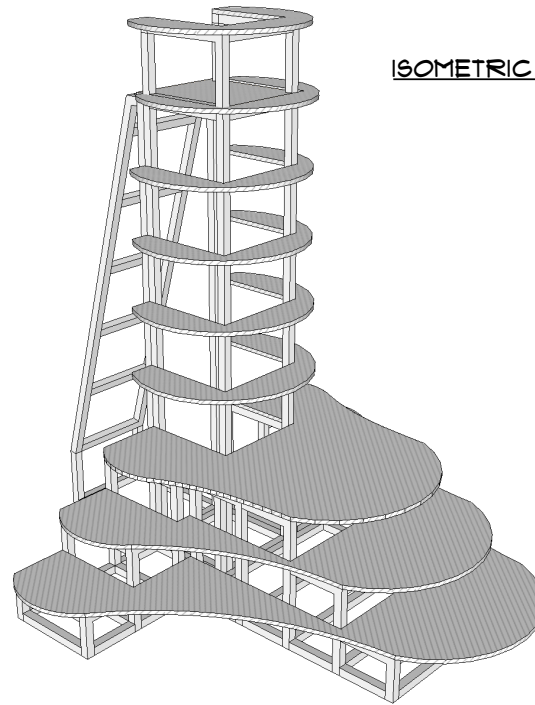

ISOMETRIC VIEW

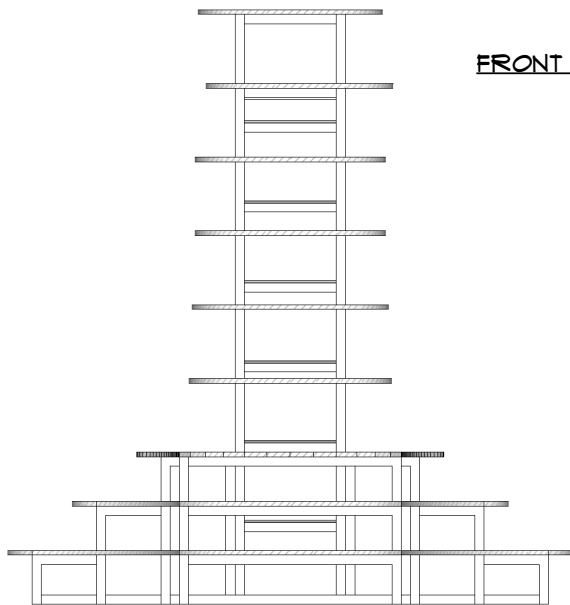

FRONT ELEVATION

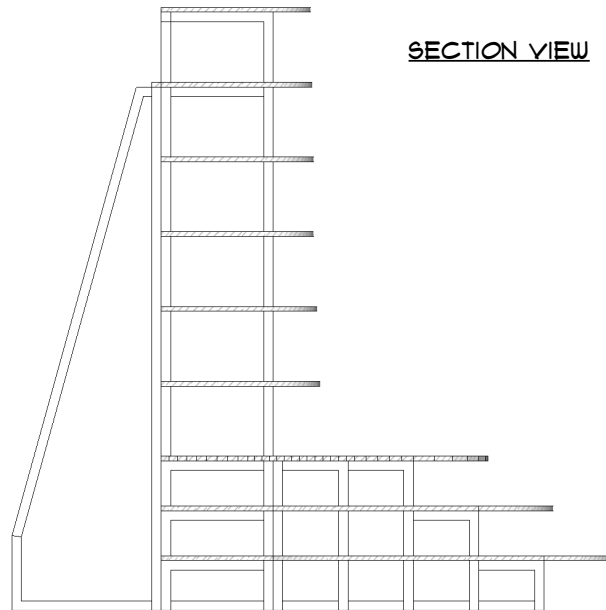

SECTION VIEW

Technical Director/Contact Information:

DANIEL CZYPIŃSKI
DCZYPIN@CALSTATELA.EDU

Drawn By: **DANIEL CZYPIŃSKI**

Revision Date: **NOVEMBER 20, 2018**

Notes:
STRUCTURE FRAME CONSTRUCTED FROM 1-1/2" BOX STEEL
TREE "RINGS" CONSTRUCTED FROM 3/4" PLYWOOD
ENTIRE STRUCTURE TO BE WRAPPED IN WHITE JERSEY FABRIC AS PROJECTION SURFACE

Project: **ONCE ON THIS ISLAND**

Director: **ERICA ROBSON**

Purpose: **TREE STRUCTURE**

Date: **OCTOBER 2018**

Scale: **NOT TO SCALE**

Plate #: **1 OF 8**

1

2

3

A

B

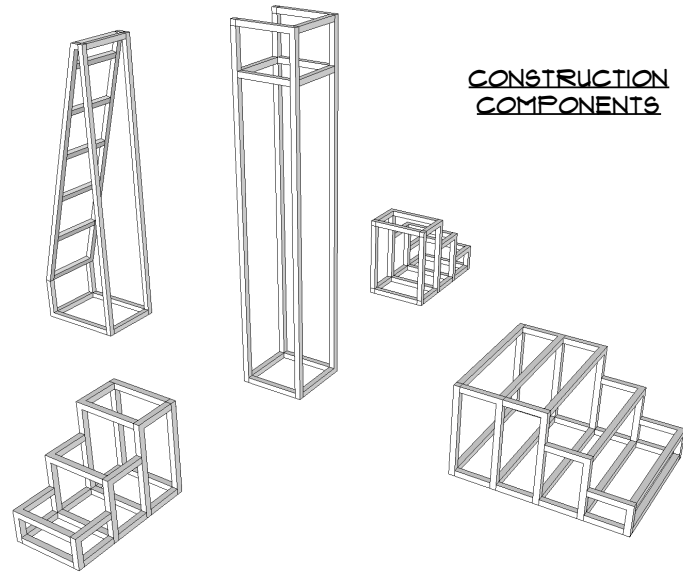

CONSTRUCTION COMPONENTS

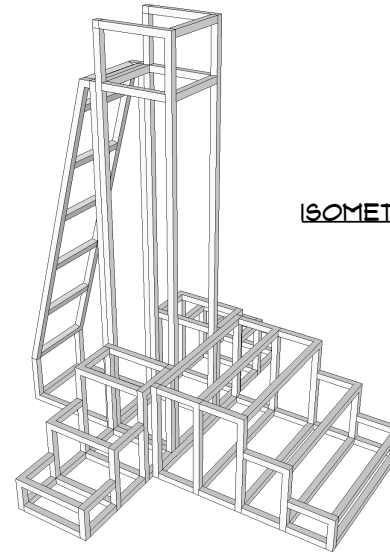

ISOMETRIC VIEW

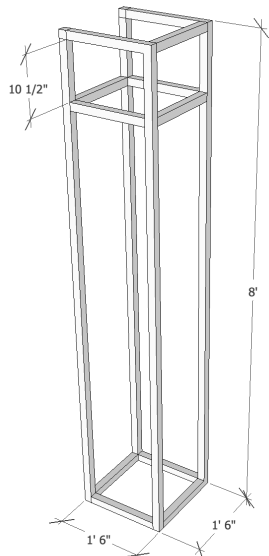

CENTER TOWER SECTION VIEW

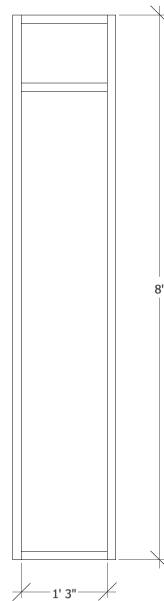

CENTER TOWER TOP VIEW

CENTER TOWER ISOMETRIC VIEW

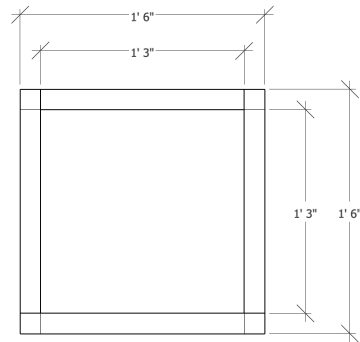

Technical Director/Contact Information:

DANIEL CZYPIŃSKI
DCZYPIN@CALSTATELA.EDU

Drawn By: DANIEL CZYPIŃSKI

Revision Date: NOVEMBER 20, 2018

Notes:

Project:

ONCE ON THIS ISLAND

Date:

OCTOBER 2018

Scale:

NOT TO SCALE

Plate #:

2
OF
8

Director: ERICA ROBSON

Purpose: TREE STRUCTURE